











# SmartRack 42U Extra-Wide Heavy-Duty Rack Enclosure Cabinet, White (SRH42UWWD8)

										
42 Rack Units	5000 lb. Stationary Load Rating	3500 lb. Rolling Load Rating	Heavy-Duty Casters	Locking Doors & Side Panels	Accommodates Standard 19-inch Equipment	Toolless Mounting Slots	Adjustable Rails with Easy-View Depth Index	Airflow Exceeds Server OEM Requirements	Integrated Baying Tabs	Square Hole Mounting

- A Adjustable Mounting Rails**
- B Adjustable PDU Mounting Rails with Toolless Mounting Slots**
- C Roof Panel** (Removable)
- D Front Door** (Lockable/Removable/Reversible)
- E Split Rear Doors** (Lockable/Removable)
- F Side Panels** (Lockable/Removable)
- G Heavy-Duty Casters**
- H Heavy-Duty Levelers**
- I Keys** (For doors and side panels)

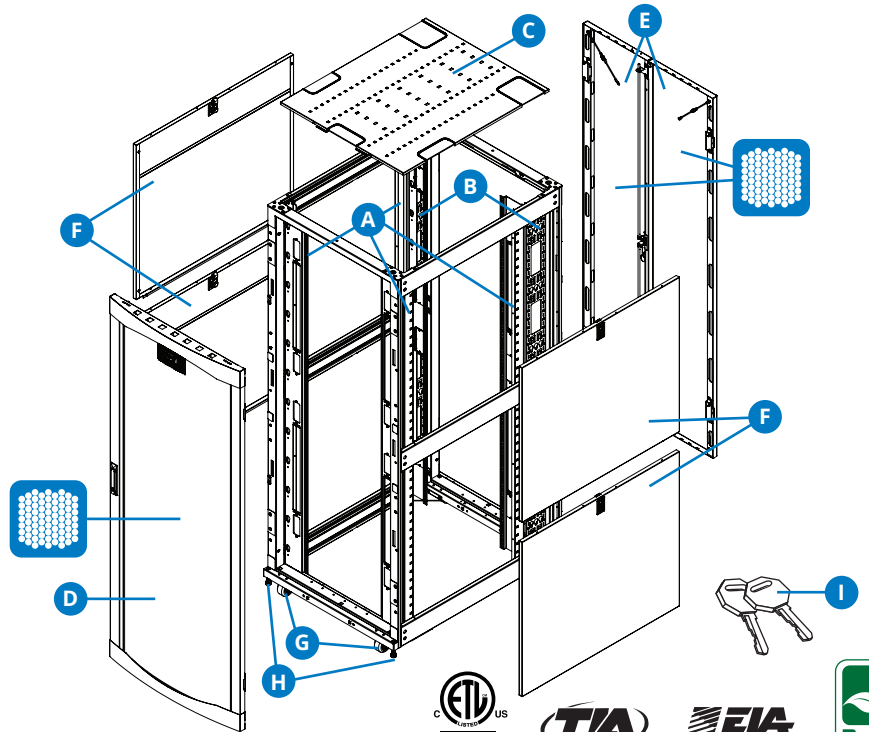

Also Includes: Owner's manual, 2 stabilizing brackets and rackmount equipment mounting hardware (50 cage nuts, 50 mounting screws, 50 nylon cup washers)



## SPECIFICATIONS

<b>Model</b>	<b>SRH42UWWD8</b>
Rack Spaces	42U
Stationary Load Rating	5000 lb. / 2268 kg
Rolling Load Rating	3500 lb. / 1588 kg
Unit Dimensions [H x W x D]	79.64 x 31.50 x 44.09 in. / 2022.8 x 800 x 1119.18 mm
Shipping Dimensions [H x W x D]	86.5 x 43.5 x 45 in. / 2197 x 1105 x 1143 mm
Unit Weight	431 lb. / 195.5 kg
Certifications	UL 2416, CSA C22.2 No 62368-1, IEC 60297-3-100, DIN 41494, IP20, TIA/EIA-310-D (Accommodates all standard 19-inch rackmount equipment regardless of vendor.)

\* Part numbers and specifications are subject to change.



Powering Business Worldwide

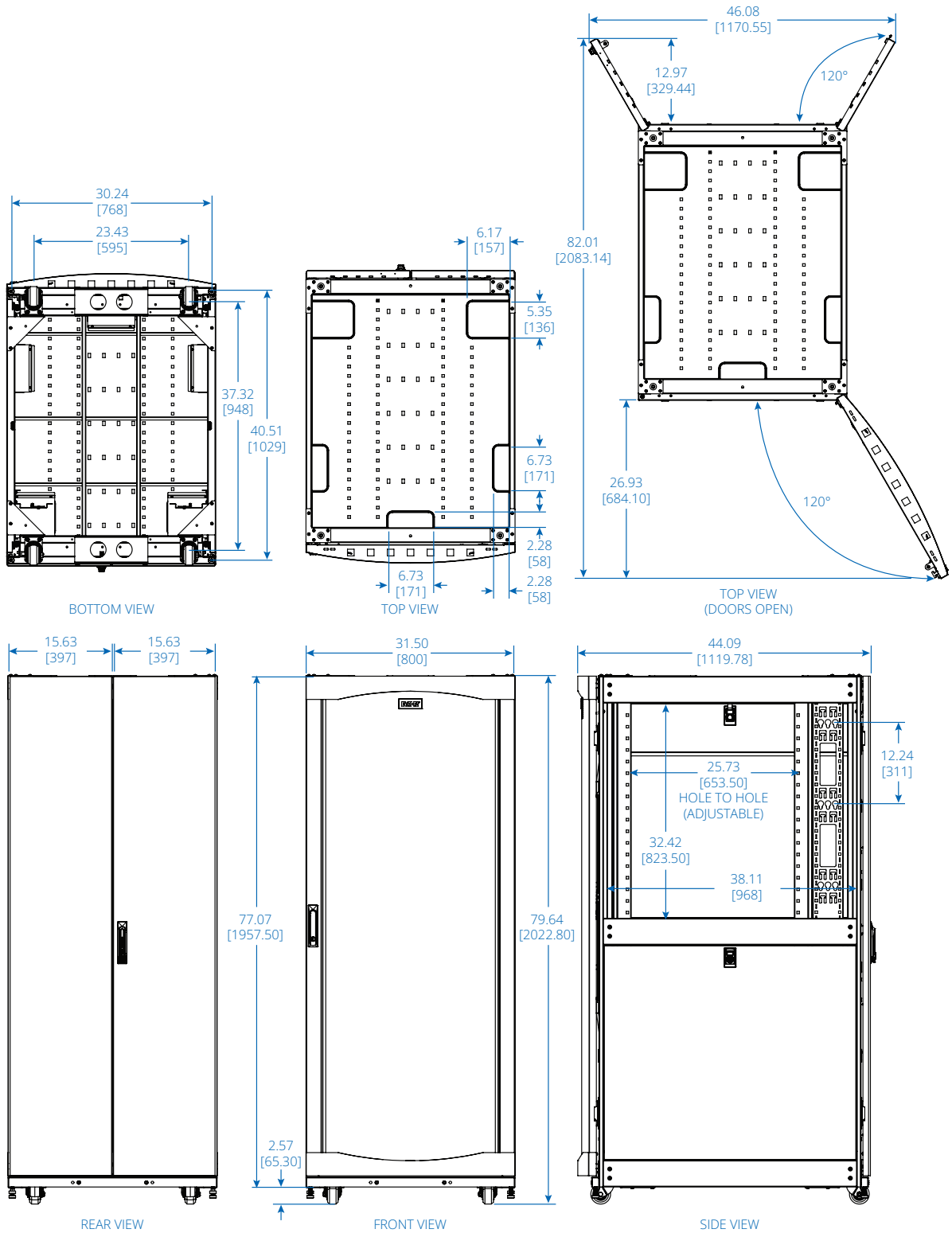

Dimensions: INCHES [mm]

Learn more at [Tripplite.Eaton.com](https://www.Tripplite.Eaton.com)



**Eaton**  
 1000 Eaton Boulevard  
 Cleveland, OH 44122  
 United States  
 Eaton.com

© 2024 Eaton  
 All Rights Reserved  
 Publication No. 24-06-028  
 September 2024

No part of this document may be reproduced in any way without the express written approval of Eaton.

Eaton reserves the right to change specifications without prior notice. Eaton is a registered trademark of Eaton. All other trademarks are properties of their respective companies.

Follow us on social media to get the latest product and support information.

