

THE INFORMATION CONTAINED IN THIS DRAWING IS THE SOLE PROPERTY OF TRIPPE MANUFACTURING. ANY REPRODUCTION IN PART OR WHOLE WITHOUT THE WRITTEN PERMISSION OF TRIPPE MANUFACTURING IS PROHIBITED.

REV.	DESCRIPTION	REVISIONS	DATE	REVISED BY
A	INITIAL DESIGN INTENT RELEASE		09/03/19	KMH

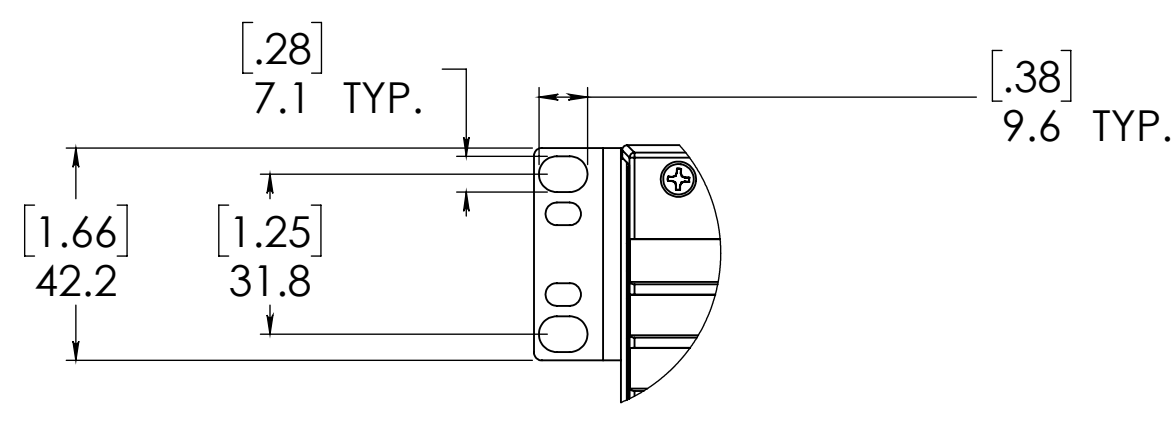

DETAIL A  
SCALE 2 : 3

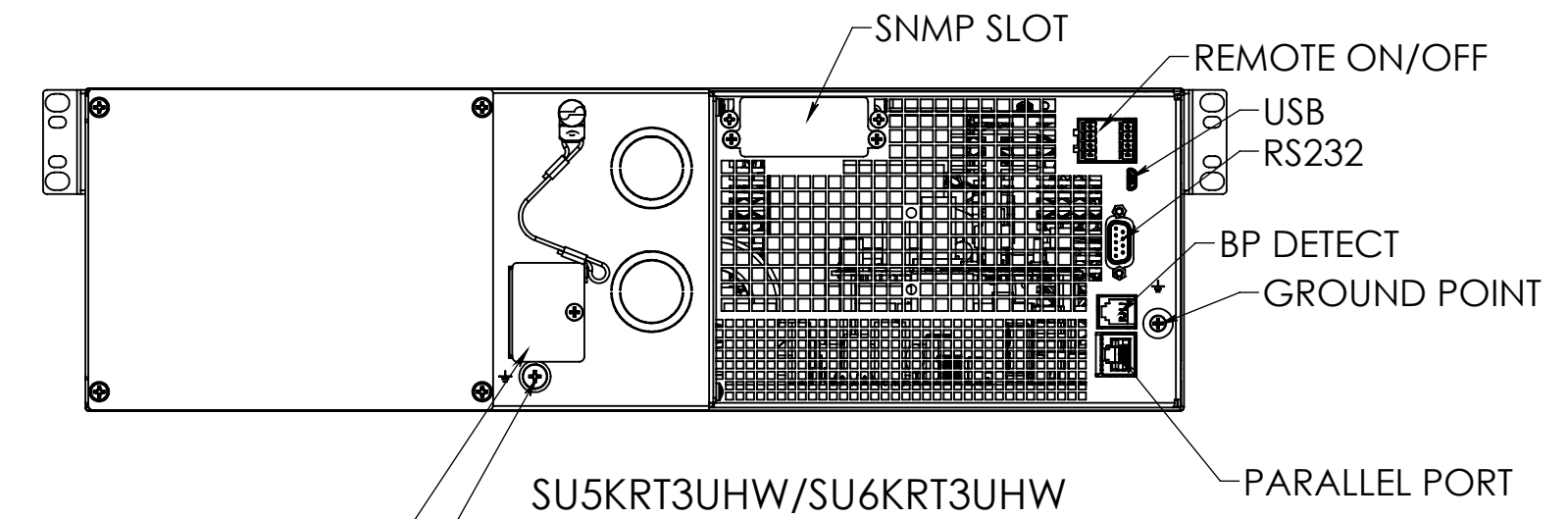
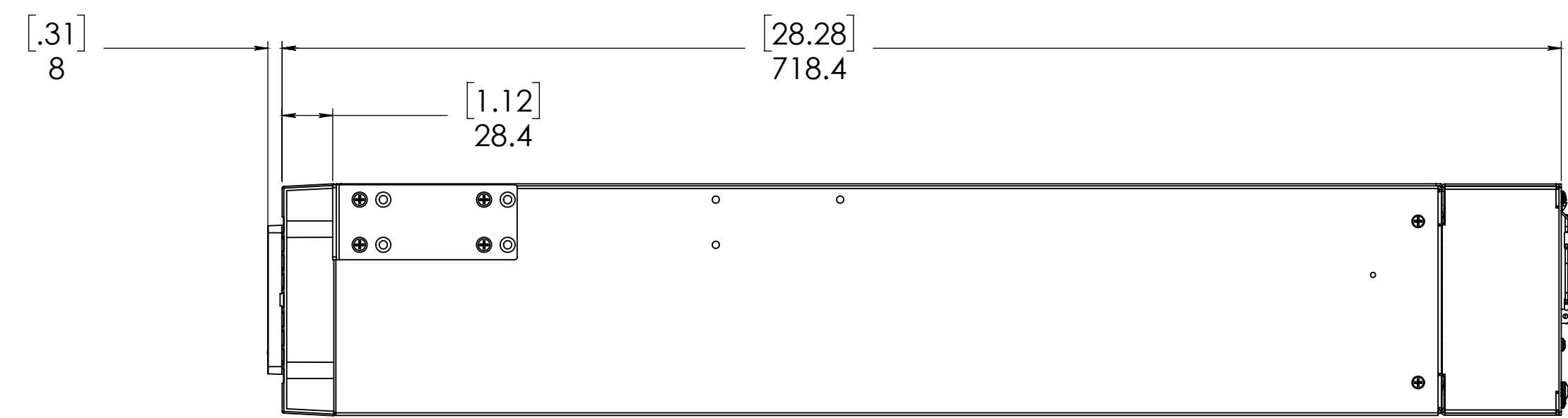
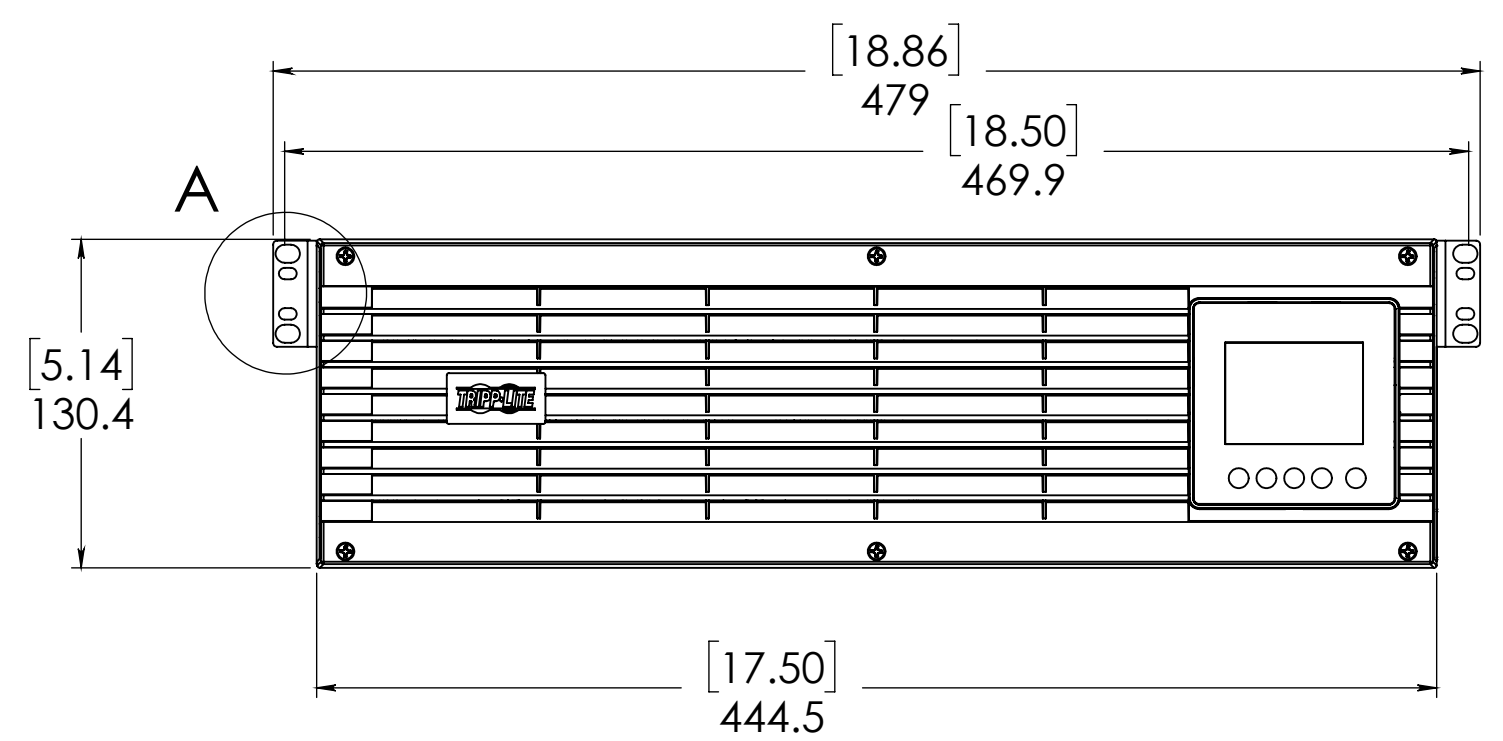
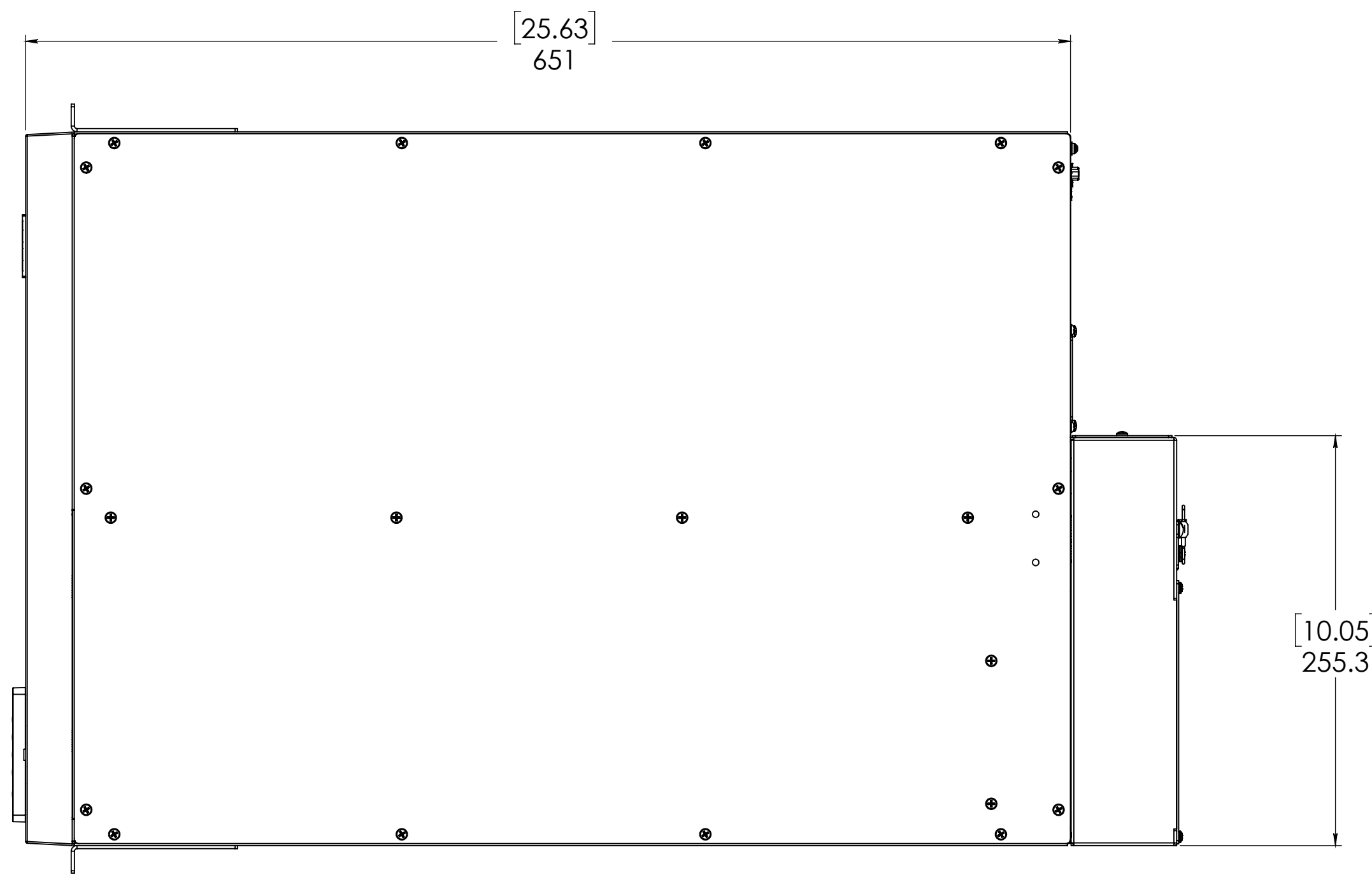

DC CONNECTOR (WITH COVER PLATE)  
GROUND POINT

SU5KRT3UHW/SU6KRT3UHW

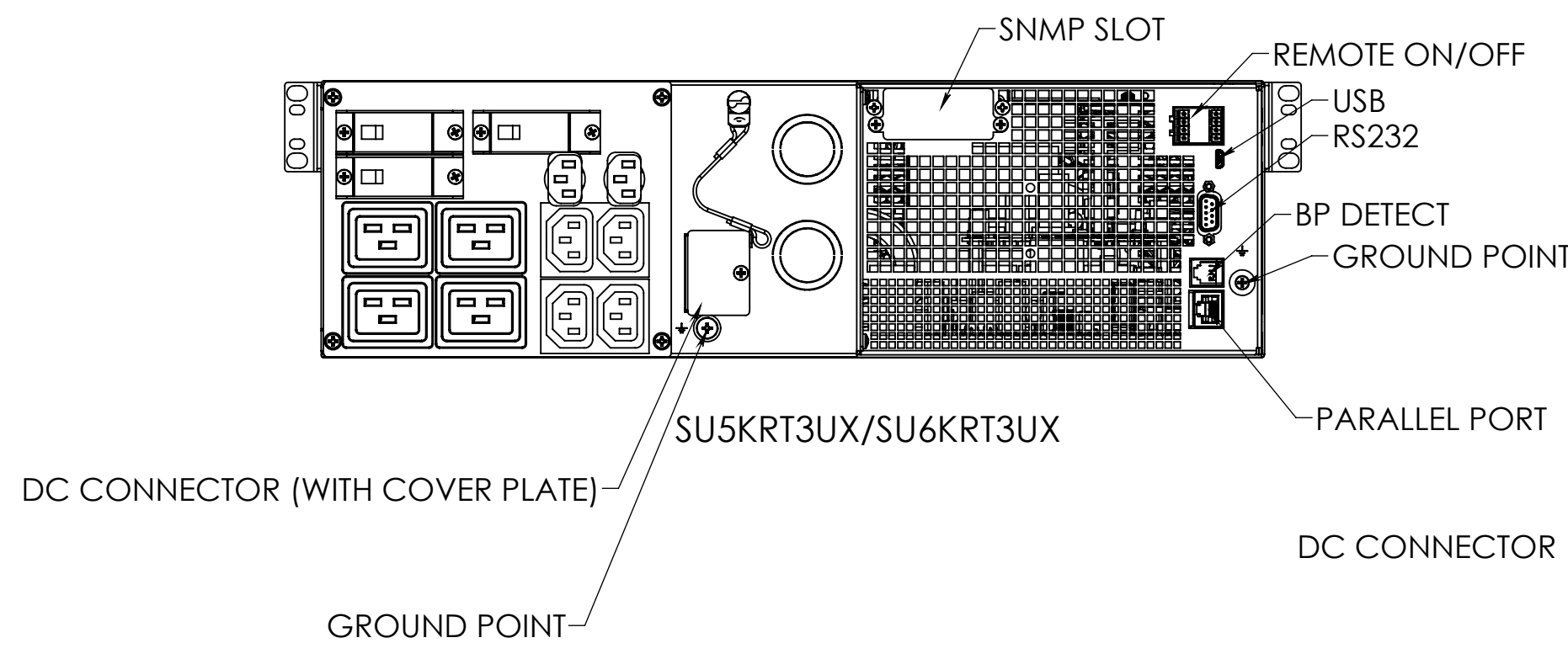

DC CONNECTOR (WITH COVER PLATE)  
GROUND POINT

SU5KRT3UX/SU6KRT3UX

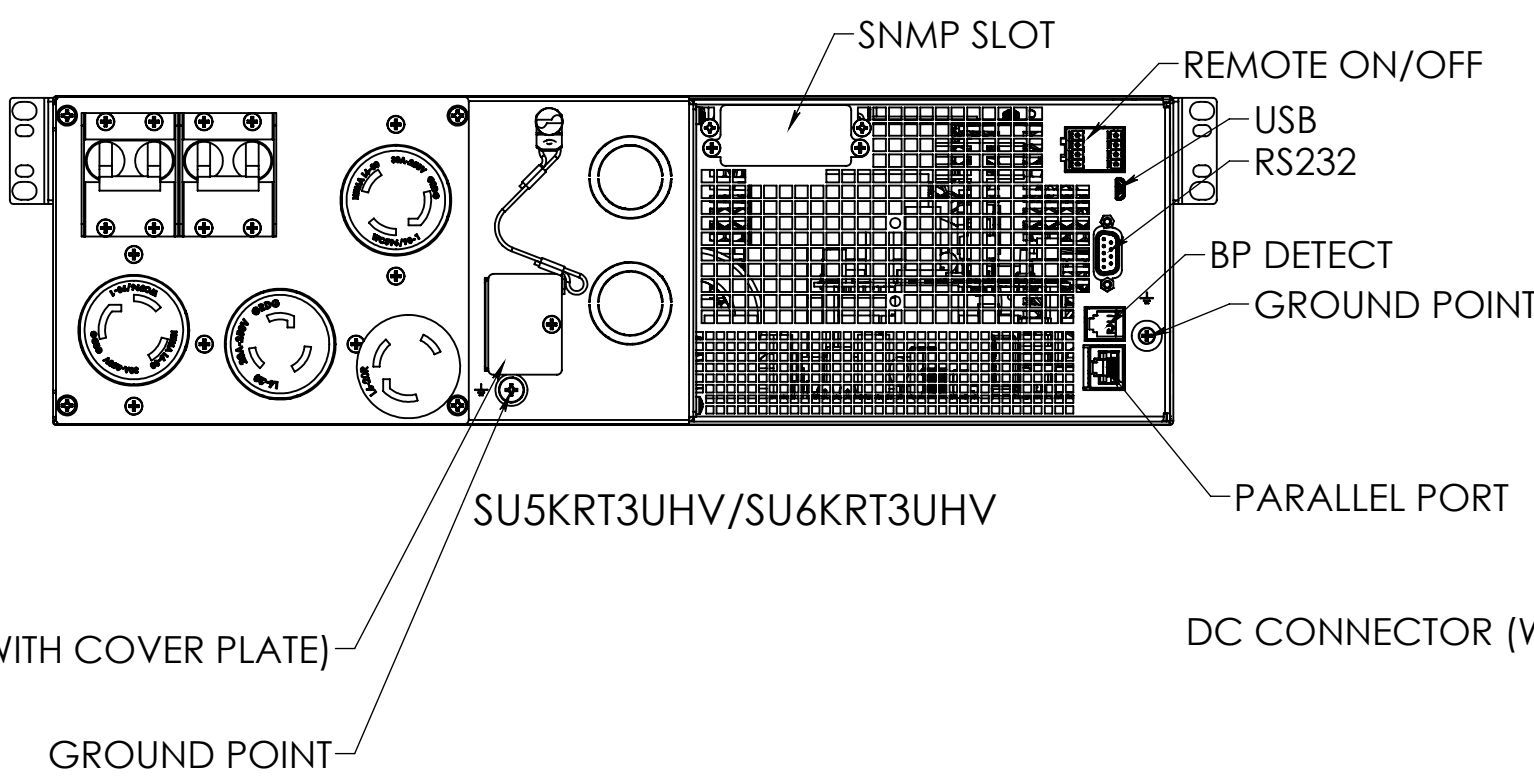

DC CONNECTOR (WITH COVER PLATE)  
GROUND POINT

SU5KRT3UHV/SU6KRT3UHV

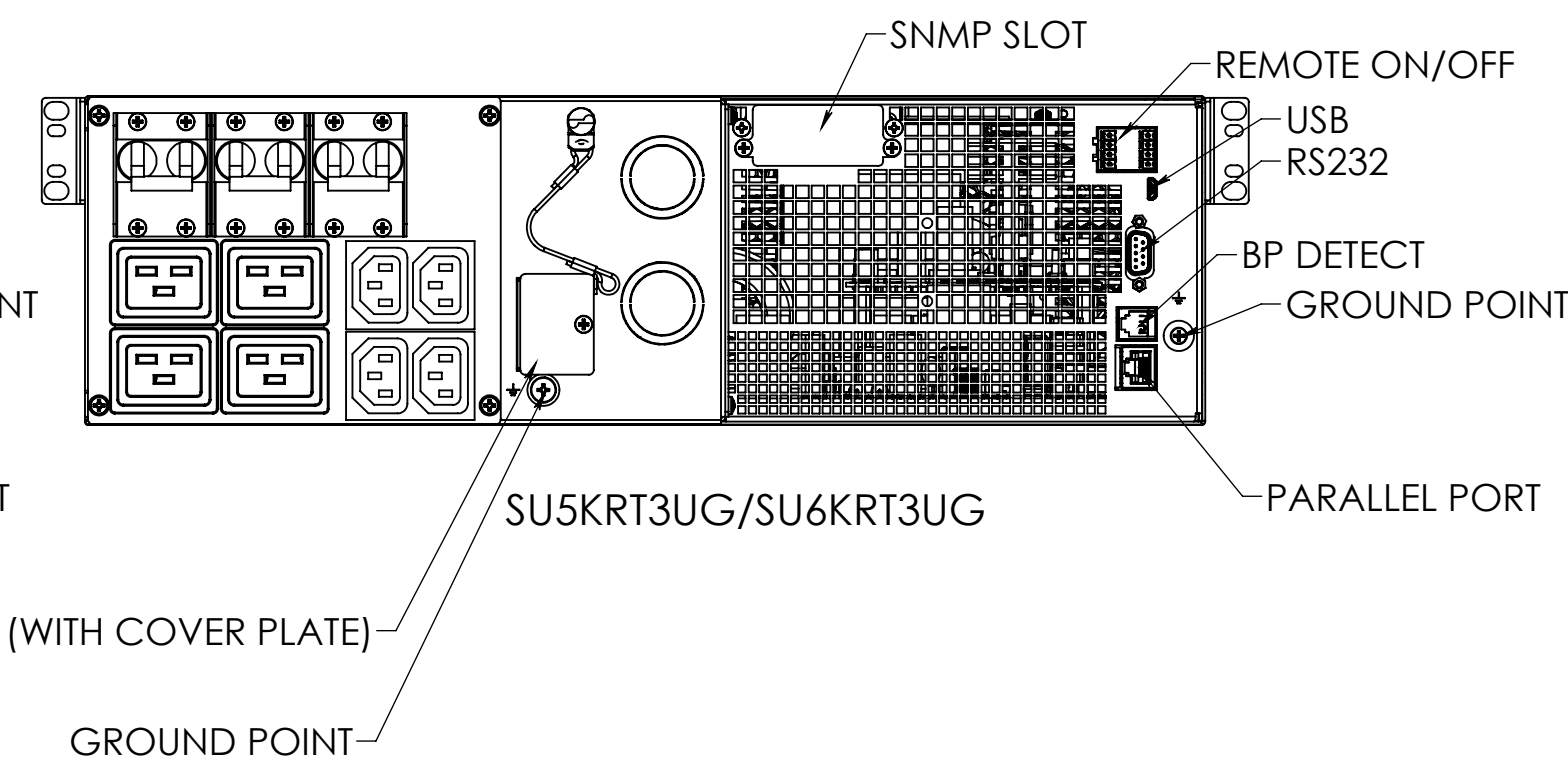

DC CONNECTOR (WITH COVER PLATE)  
GROUND POINT

SU5KRT3UG/SU6KRT3UG

NOTES:  
1. DIMENSIONS IN MILLIMETERS [INCHES]

UNLESS OTHERWISE SPECIFIED DIMENSIONS ARE IN INCHES TOLERANCES ARE: DECIMALS .5 .4 .3 .2 .15 .1 .050 ANGLES ±.5 THIRDS ANGLE PROJECTION	APPROVALS DRAWN: KMH CHECKED: ERECT ENG DATE: 09/03/19	CAD GENERATED DRAWING DO NOT MANUALLY UPDATE	TRIPPE MANUFACTURING COMPANY 1111 WEST 35th STREET CHICAGO, IL 60659
	MATERIAL: -- FINISH: -- DO NOT SCALE DRAWING	CHECKED: ERECT ENG MFG ENG: -- QUAL ENG: --	SUBMITTAL DRAWING SU5KRT3UXX/SU6KRT3UXX