

MODEL:

# PDU3XEVS6G60B

## 3-Phase Switched 0U Vertical PDU



415V  
3-Phase Input



IEC 309 60A  
Red (3P+N+E)  
Plug



240V Single-  
Phase Output



30 Outlets



25.2kW Load  
Capacity



Touchscreen  
LCD



HTML5  
Network  
Interface



0U  
Rackmount



Toolless  
Mounting  
Buttons

- A** Color Touchscreen LCD
- B** C13 and C19 Outlets with Multi-Function LEDs
- C** 20A Single Pole Hydraulic Magnetic Circuit Breakers
- D** C13 and C19 Plug-Lock Inserts
- E** Removable Mounting Brackets
- F** Toolless Mounting Buttons with Removable 90° Rotation Brackets
- G** 6 ft. Input Power Cord
- H** IEC 309 60A Red (3P+N+E) Input Plug (IP44)
- I** Durable Metal Case
- J** LX Platform Interface
- K** USB-B Port (for Direct Console Access)
- L** USB-A Ports (for EnviroSense2 Sensors)
- M** RJ45 Configuration Port
- N** Ethernet Port
- O** Network Interface Reset Button

Not Shown:  
Configuration Cable,  
Owner's Manual

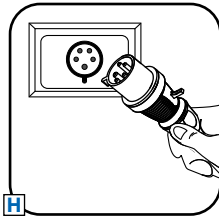

AC Input Connection: Insert IEC 309 60A Red (3P+N+E) plug into compatible utility, generator or UPS outlet.

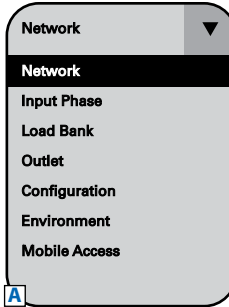

Color Touchscreen LCD: Easily toggle between menus to monitor input current level per phase, output current per load bank and per outlet, environmental sensor data and network information. It also generates a unique QR code to allow access to the switchable PDU through a mobile device.

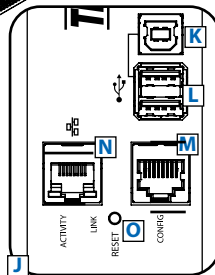
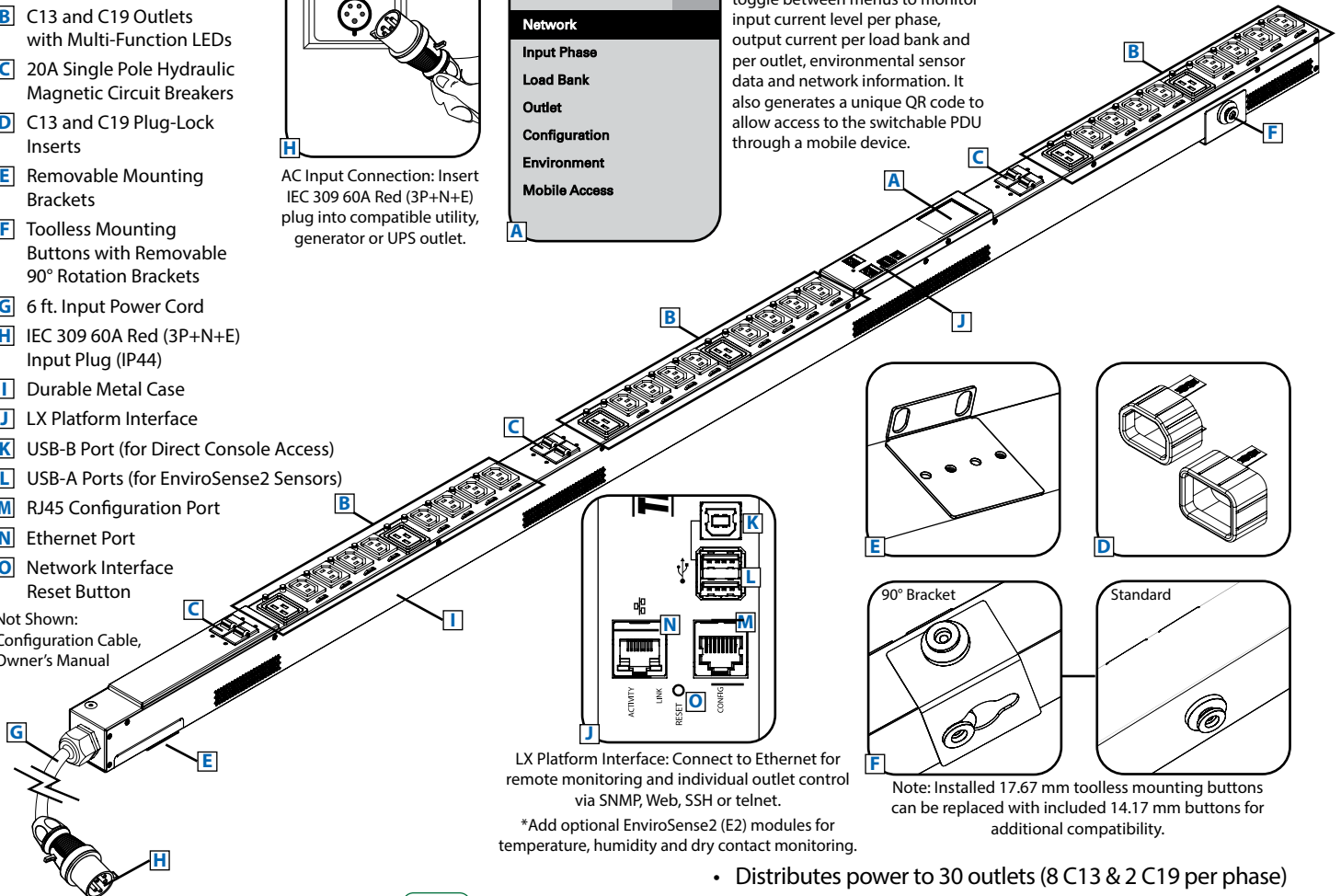

LX Platform Interface: Connect to Ethernet for remote monitoring and individual outlet control via SNMP, Web, SSH or telnet.

\*Add optional EnviroSense2 (E2) modules for temperature, humidity and dry contact monitoring.

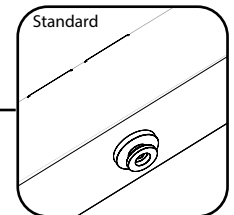
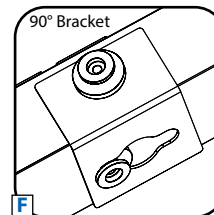
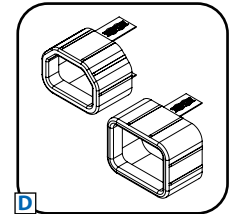
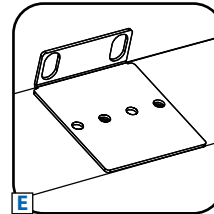

Note: Installed 17.67 mm toolless mounting buttons can be replaced with included 14.17 mm buttons for additional compatibility.

### Specifications

Model	PDU3XEVS6G60B
Voltage	415V (3-Phase Input/Single-Phase Output)
Frequency	50 / 60 Hz
Load Capacity	25.2kW
Input Plug	IEC 309 60A Red (3P+N+E) (IP44 Protection Rating - Splash-Proof)
Input Cord Length	6 ft. / 1.8 m
Outlets	30 (24 C13 / 6 C19)
Primary Mounting Option	0U (Vertical) Rack Mount
Unit Dimensions	70 x 2.17 x 2.52 in. / 1778 x 55 x 64 mm
Unit Weight	19.1 lb. / 8.6 kg
Standards	Tested to EN 60950-1 (US & Canada), NOM (Mexico) FCC Class A, IP44 Protection Rating (Plug)

Tripp Lite has a policy of continuous improvement. Specifications are subject to change without notice.



- Distributes power to 30 outlets (8 C13 & 2 C19 per phase)
- Java-free, HTML5-based network interface allows for remote monitoring and control via SNMP, Web, SSH or telnet
- Reports current for each **phase**, **bank**, and **outlet** in real-time
- Perfect for rack-mount server, network and telecom applications

**SEE NEXT PAGE FOR DETAILED UNIT MEASUREMENTS**



1111 W. 35th Street  
Chicago, IL 60609 USA  
773.869.1234

[www.tripplite.com](http://www.tripplite.com)

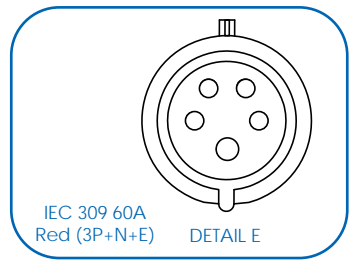
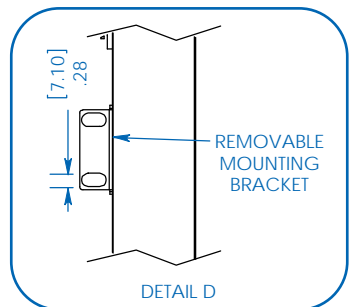
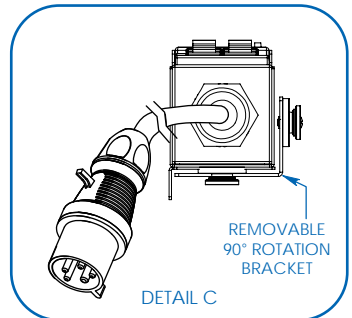
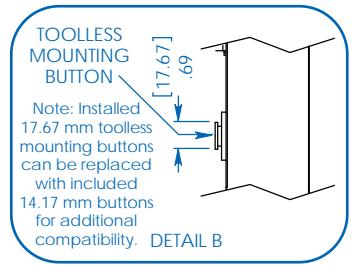
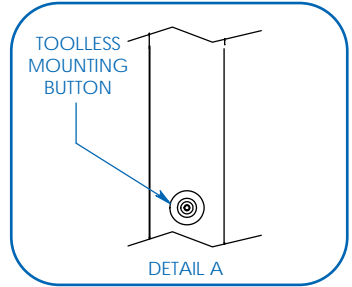
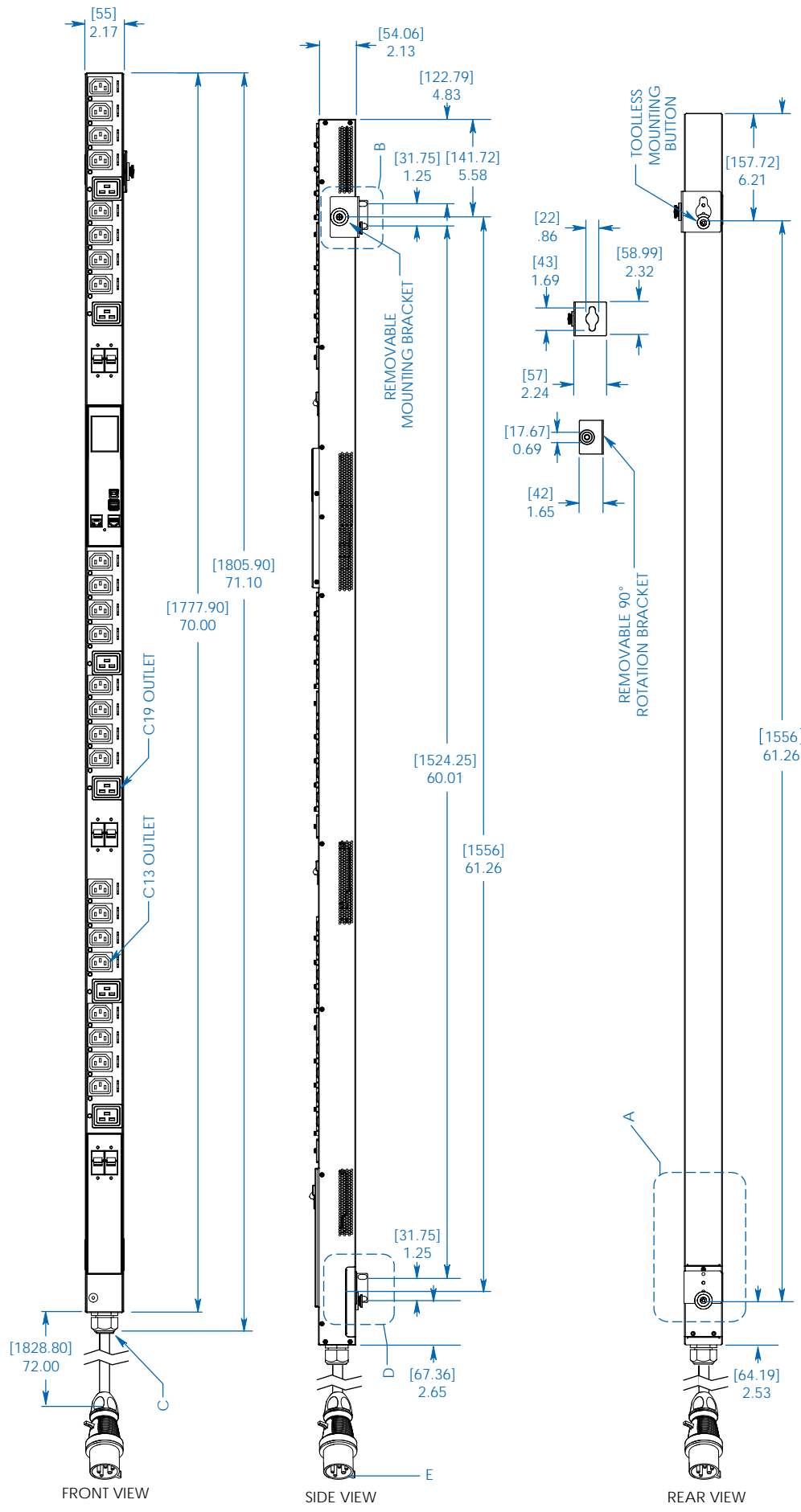

MODEL:  
**PDU3XEVSR6G60B**



1111 W. 35th Street  
Chicago, IL 60609 USA  
773.869.1234

[www.tripplite.com](http://www.tripplite.com)

Dimensions: [mm] INCHES

Tripp Lite has a policy of continuous improvement. Specifications are subject to change without notice.