

MODEL:

PDU3XEVS6G32B

3-Phase Switched 0U Vertical PDU



**380V/400V
3-Phase Input**



**IEC 309 32A
Red (3P+N+E)
Plug**



**220V/230V
Single-Phase
Output**



30 Outlets



22.2kW

**22.2kW Load
Capacity**



**Touchscreen
LCD**



**HTML5
Network
Interface**



**0U
Rack-Mount**



**Toolless
Mounting
Buttons**

- A** Multimode Load Meter
- B** C13 and C19 Outlets with Multi-Function LEDs
- C** 20A Single Pole Hydraulic Magnetic Circuit Breakers
- D** C13 and C19 Plug-Lock Inserts
- E** Removable Mounting Brackets
- F** Toolless Mounting Buttons with Removable 90° Rotation Brackets

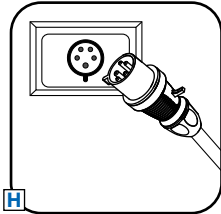

AC Input Connection: Insert IEC 309 32A Red (3P+N+E) plug into compatible utility, generator or UPS outlet.

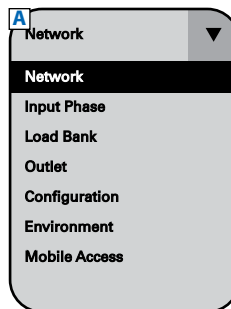

Color Touchscreen LCD: Easily toggle between menus to monitor input current level per phase, output current per load bank and per outlet, environmental sensor data and network information. It also generates a unique QR code to allow access to the switchable PDU through a mobile device.

- G** 6 ft. Input Power Cord
- H** IEC 309 32A Red (3P+N+E) Input Plug (IP44)
- I** Durable Metal Case
- J** LX Platform Interface
- K** USB-B Port (for Direct Console Access)
- L** USB-A Ports (for EnviroSense2 Sensors)
- M** RJ45 Configuration Port
- N** Ethernet Port
- O** Network Interface Reset Button

Not Shown:
Configuration Cable,
Owner's Manual

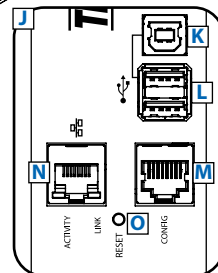
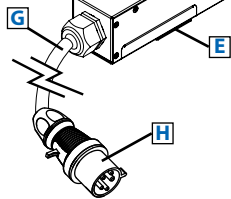

LX Platform Interface: Connect to Ethernet for remote monitoring and individual outlet control via SNMP, Web, SSH or telnet.

*Add optional EnviroSense2 (E2) modules for temperature, humidity and dry contact monitoring.

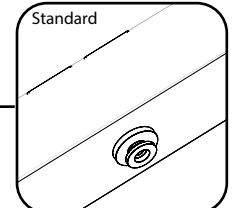
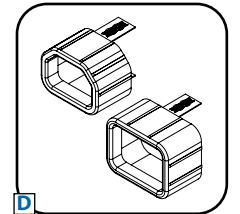
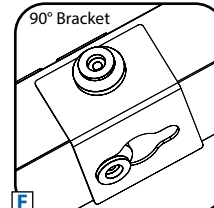
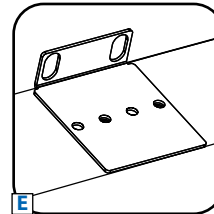

Note: Installed 17.67 mm toolless mounting buttons can be replaced with included 14.17 mm buttons for additional compatibility.

Specifications

Model	PDU3XEVS6G32B
Voltage	380V/400V (3-Phase Input/Single-Phase Output)
Frequency	50 / 60 Hz
Load Capacity	22.2kW (400V/230V), 21.1kW (380V/220V)
Input Plug	IEC 309 32A Red (3P+N+E) (IP44 Protection Rating - Splash-Proof)
Input Cord Length	6 ft. / 1.8 m
Outlets	30 (24 C13 / 6 C19)
Primary Mounting Option	0U (Vertical) Rack-Mount
Unit Dimensions (H x W x D)	70 x 2.17 x 2.52 in. / 1778 x 55 x 64 mm
Unit Weight	15.9 lb. / 7.2 kg
Standards	Tested to EN 60950-1, CE Class A, IP44 Protection Rating (Plug)

Tripp Lite has a policy of continuous improvement. Specifications are subject to change without notice.



- Distributes power to 30 outlets (8 C13 & 2 C19 per load bank)
- Java-free, HTML5-based network interface allows for remote monitoring and control via SNMP, Web, SSH or telnet
- Reports current for each **phase, bank and outlet** in real-time
- Perfect for rack-mount server, network and telecom applications

SEE NEXT PAGE FOR DETAILED UNIT MEASUREMENTS



1111 W. 35th Street
Chicago, IL 60609 USA
773.869.1234
www.triplite.com

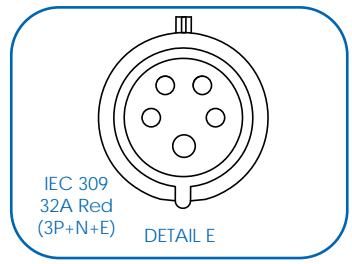
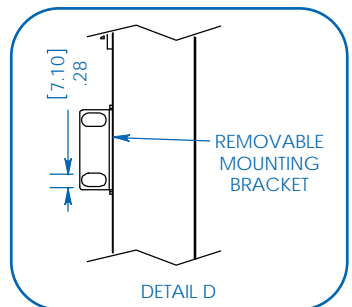
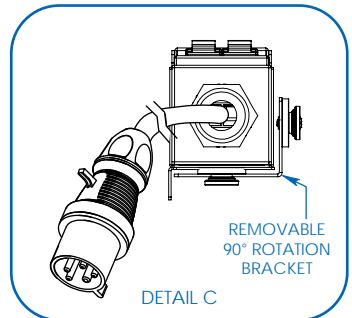
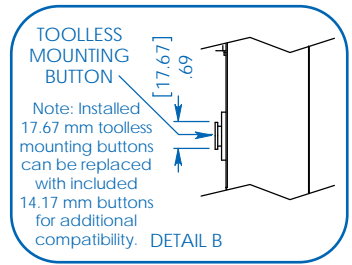
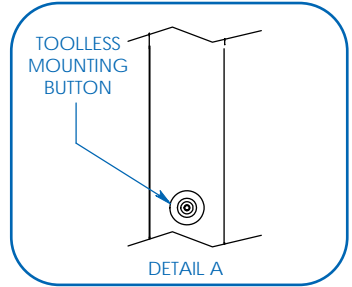
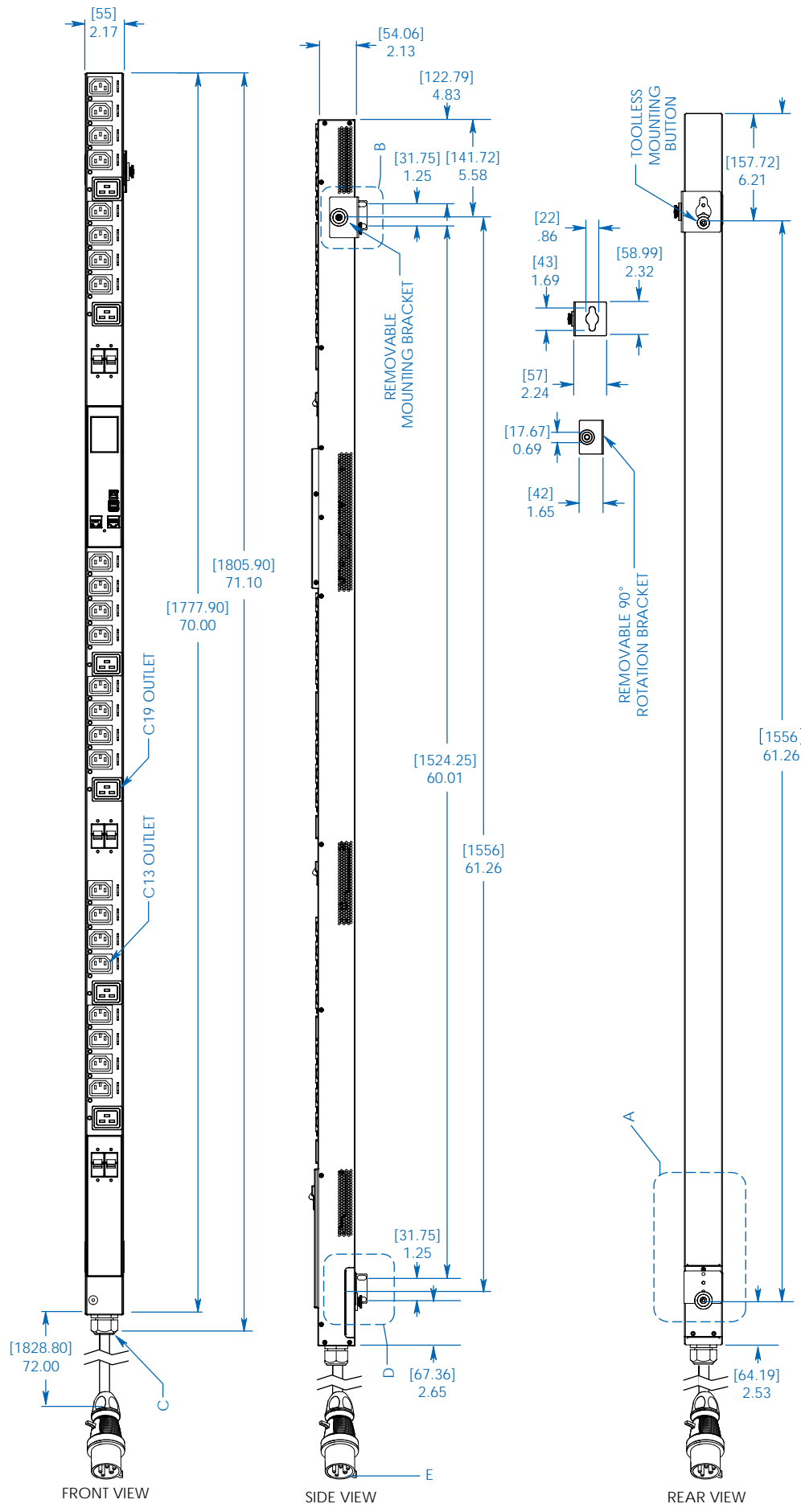

Dimensions: [mm] INCHES

Tripp Lite has a policy of continuous improvement. Specifications are subject to change without notice. Photos and illustrations may differ slightly from actual products.

MODEL:
PDU3XEVS6G32B



1111 W. 35th Street
Chicago, IL 60609 USA
773.869.1234

www.tripplite.com