

MODEL:

PDU3VN6L2120

3-Phase Monitored Rack-Mount PDU



**208V
3-Phase
Input**



**NEMA
L21-20P
Plug**



**208V
Single-Phase
Output**



C19



5-15/20R



C13



**5.7kW
Load
Capacity**



**Multi-
Function
Meter**

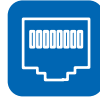

**Network
Interface**



**0U
Rackmount**



**Toolless
Mounting
Buttons**

- A** Multi-Function Meter
- B** C13, C19 and 5-15/20R Outlets with Multi-Function Bank LEDs
- C** C13 and C19 Plug Inserts
- D** Removable Mounting Brackets
- E** Toolless Mounting Buttons with Removable 90° Rotation Brackets
- F** 6 ft. Input Power Cord
- G** NEMA L21-20P Input Plug
- H** Durable Metal Case
- I** Network Interface
- J** RJ45 Ethernet Jack
- K** Manual Configuration Port
- L** Environmental Monitoring Port
- M** Network Interface Reset Button

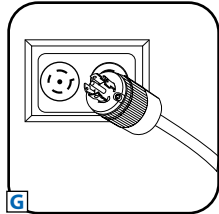

AC Input Connection: Insert NEMA L21-20P plug into compatible utility, generator or UPS outlet.

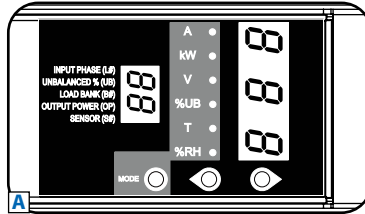

Multi-Function Meter: Display the load for each phase, bank or total output; displays temperature or humidity*; displays the IP address or rotate the display 180°.

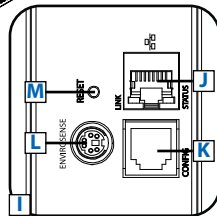
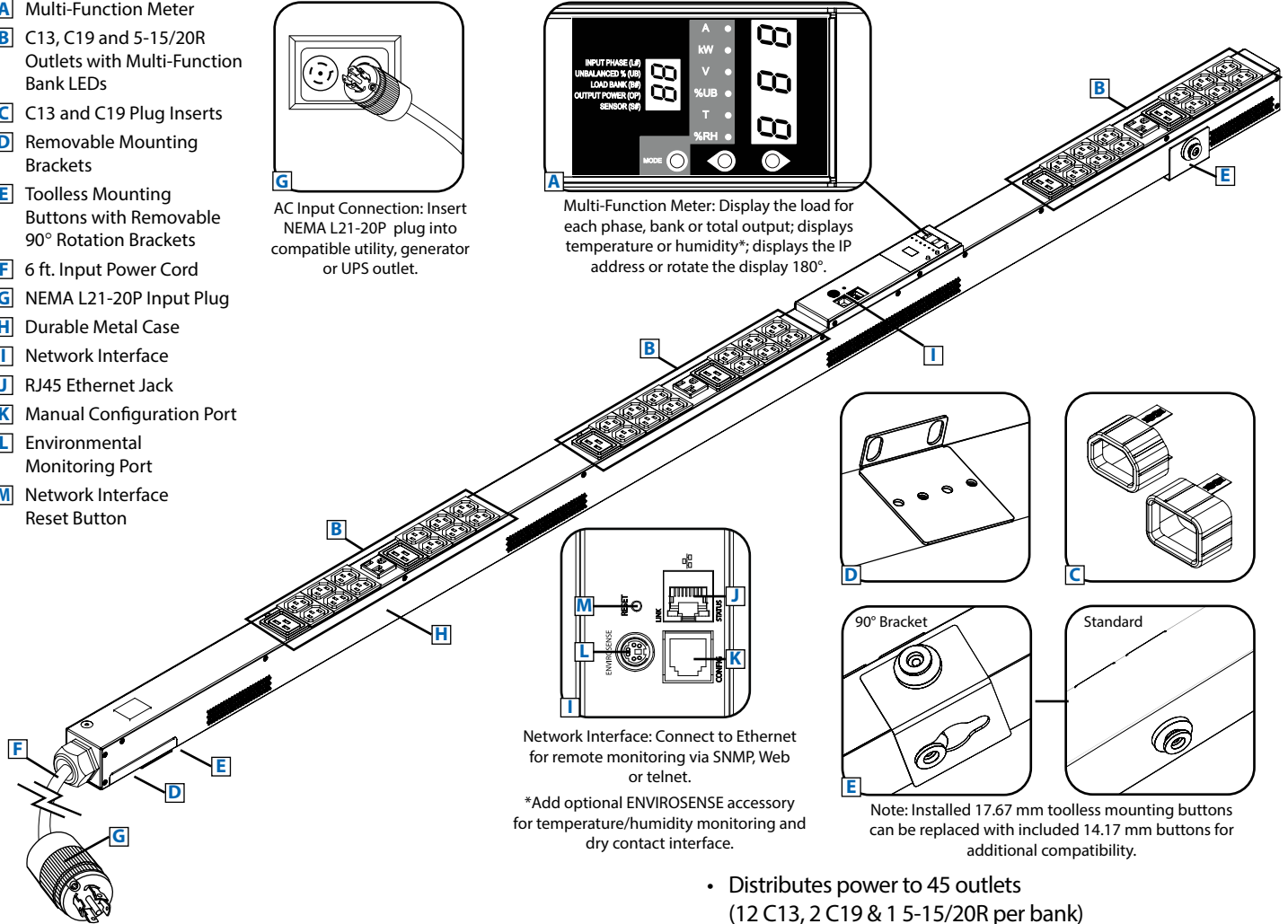

Network Interface: Connect to Ethernet for remote monitoring via SNMP, Web or telnet.

*Add optional ENVIROSENSE accessory for temperature/humidity monitoring and dry contact interface.

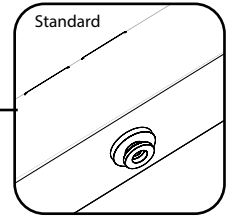
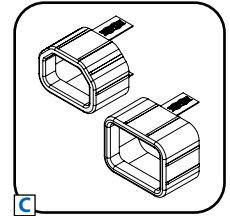
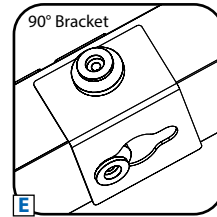
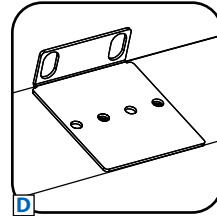

Note: Installed 17.67 mm toolless mounting buttons can be replaced with included 14.17 mm buttons for additional compatibility.

- Distributes power to 45 outlets (12 C13, 2 C19 & 1 5-15/20R per bank)
- Remote monitoring and control via SNMP, Web or telnet
- Displays load for each bank, phase and total output in real time with 1% billing-grade accuracy
- Perfect for rack-mount server, network and telecom applications

SEE NEXT PAGE FOR DETAILED UNIT MEASUREMENTS



1111 W. 35th Street
Chicago, IL 60609 USA
773.869.1234
www.tripplite.com

Specifications

Model	PDU3VN6L2120
Voltage	208V (3-Phase Input/Single-Phase Output)
Frequency	50/60 Hz
Load Capacity	5.7kW (208V/120V)
Input Plug	NEMA L21-20P
Input Cord Length	6 ft.
Outlets	45 (36 C13 / 6 C19 / 3 5-15/20R)
Primary Mounting Option	0U (Vertical) Rackmount
Unit Weight & Dimensions	13.5 lb. / 70 x 2.17 x 2.86 (H x W x D in inches) 6.1 kg / 1778 x 55 x 72.6 (H x W x D in millimeters) <i>See next page for detailed unit measurements.</i>
Standards	Tested to UL/CSA 60950-1 (US & Canada), NOM (Mexico), FCC Class A, RoHS, TAA Compliant



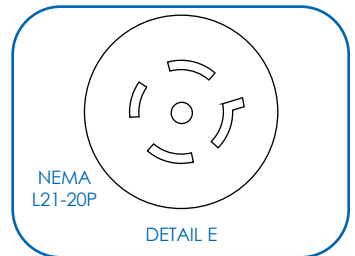
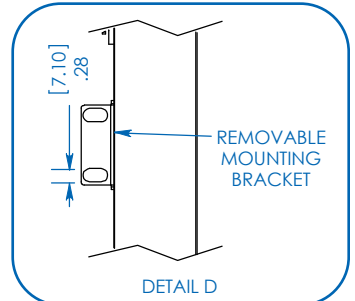
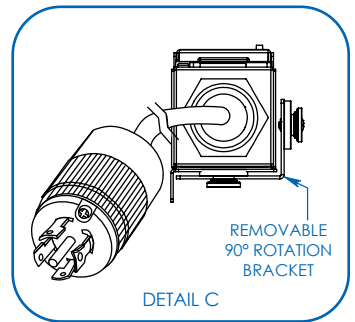
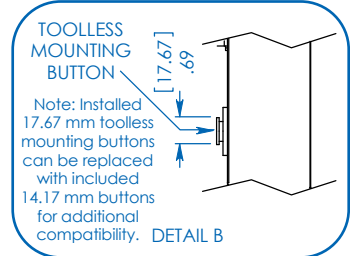
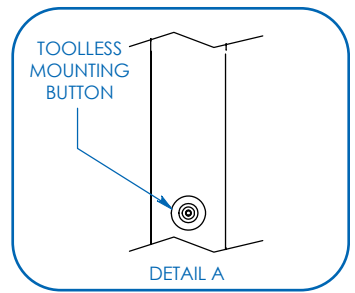
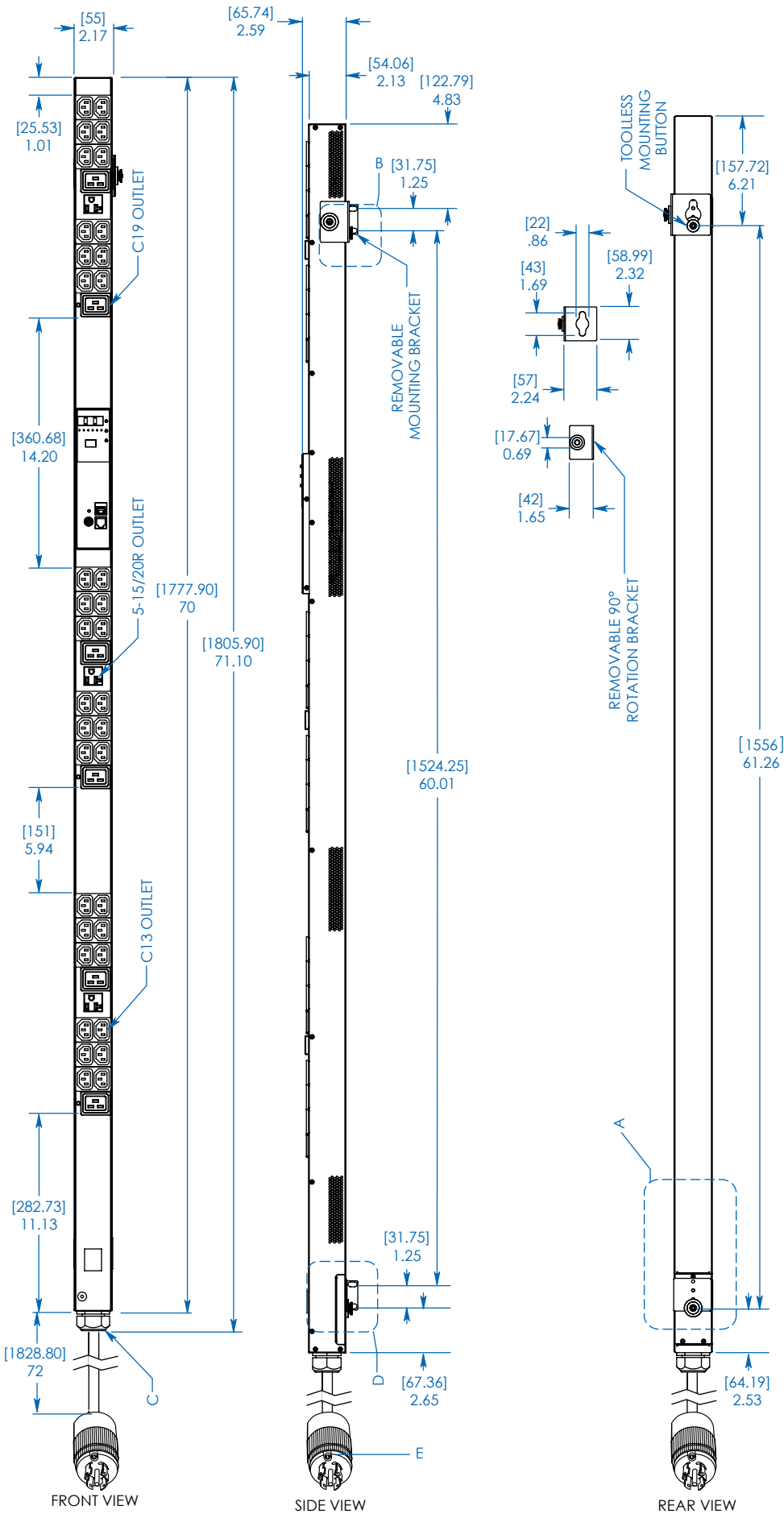

MODEL:
PDU3VN6L2120



1111 W. 35th Street
Chicago, IL 60609 USA
773.869.1234

www.tripplite.com

Dimensions: [mm] INCHES

Tripp Lite has a policy of continuous improvement. Specifications are subject to change without notice.