

MODEL:

PDU3EVN6H50B

3-Phase Monitored 0U Vertical PDU

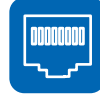

200/208/240V
3-Phase Input

Hubbell 50A
CS8365C Plug

200/208/240V
Single-Phase
Output

48 Total
Outlets

14.5kW Load
Capacity

Touchscreen
LCD

Network
Interface

0U
Rackmount

Toolless
Mounting
Buttons

- A** Color Touchscreen LCD
- B** C13 and C19 Outlets with Multi-Function LEDs
- C** 20A 2-Pole Hydraulic Magnetic Circuit Breakers
- D** C13 and C19 Plug Inserts
- E** Removable Mounting Brackets
- F** Toolless Mounting Buttons with Removable 90° Rotation Brackets
- G** 6 ft. Input Power Cord
- H** Hubbell 50A CS8365C Input Plug
- I** LX Platform Interface
- J** USB-B Port (for Direct Console Access)
- K** USB-A Ports (for EnviroSense2 Sensors)
- L** RJ45 Configuration Port
- M** Ethernet Port
- N** Network Interface Reset Button

Color Touchscreen LCD: Easily toggle between menus to monitor input current level per phase, output current per load bank, environmental sensor data and network information. It also generates a unique QR code to allow access to the monitored PDU through a mobile device.

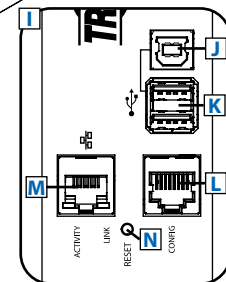
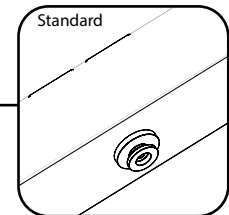
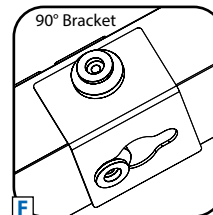
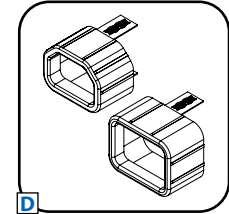
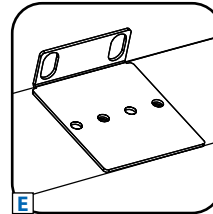
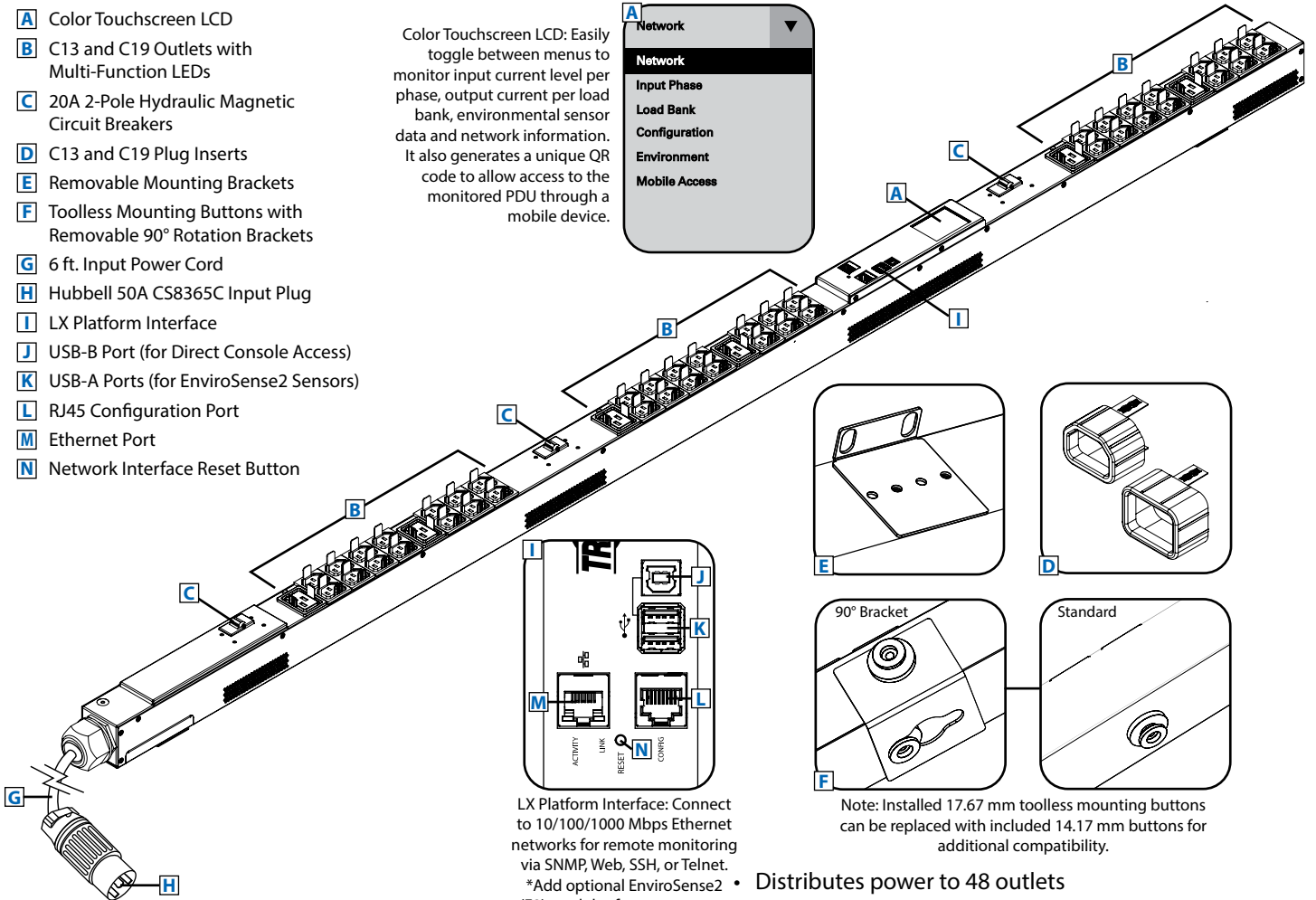
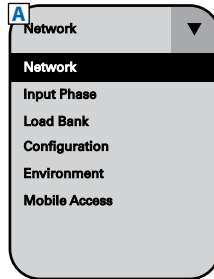

LX Platform Interface: Connect to 10/100/1000 Mbps Ethernet networks for remote monitoring via SNMP, Web, SSH, or Telnet. *Add optional EnviroSense2 (E2) modules for temperature, humidity, and dry contact signaling.

Note: Installed 17.67 mm toolless mounting buttons can be replaced with included 14.17 mm buttons for additional compatibility.

- Distributes power to 48 outlets (14 C13 and 2 C19 per phase)
- Java-free, HTML5-based network interface allows for remote monitoring via SNMP, Web, SSH or Telnet
- Displays load for any output phase in real time
- Perfect for rack-mount server, network and telecom applications

SEE NEXT PAGE FOR DETAILED UNIT MEASUREMENTS



1111 W. 35th Street
Chicago, IL 60609 USA
773.869.1234
www.tripplite.com

Specifications

Model	PDU3EVN6H50B
Voltage	200/208/240V (3-Phase Input, Single-Phase Output)
Frequency	50/60 Hz
Load Capacity	12.1kW (200V), 12.6kW (208V), 14.5kW (240V)
Input Connector	Hubbell 50A CS8365C Input Plug
Cord Length	6 ft. / 1.8 m
Outlets	48 (42 C13 / 6 C19)
Primary Mounting Option	0U (Vertical) Rack-mount
Unit Dimensions	70 x 2.17 x 2.59 in. / 1778 x 551 x 65 mm
Unit Weight	17.2 lb. / 7.8 kg
Standards	Tested to UL 60950-1 (US & Canada), NOM (Mexico), FCC Class A; RoHS; TAA



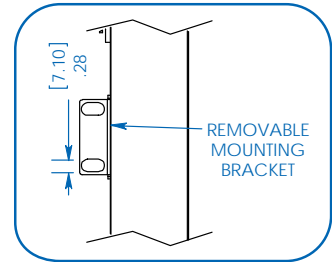
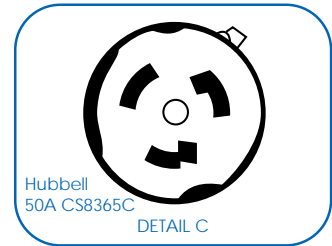
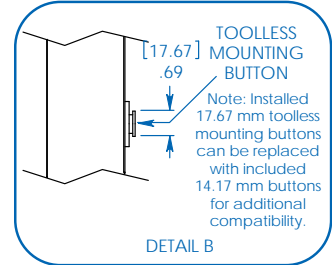
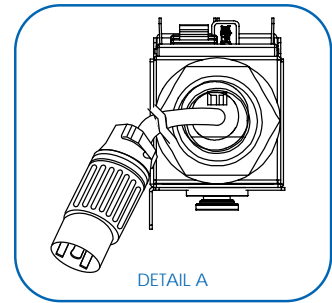
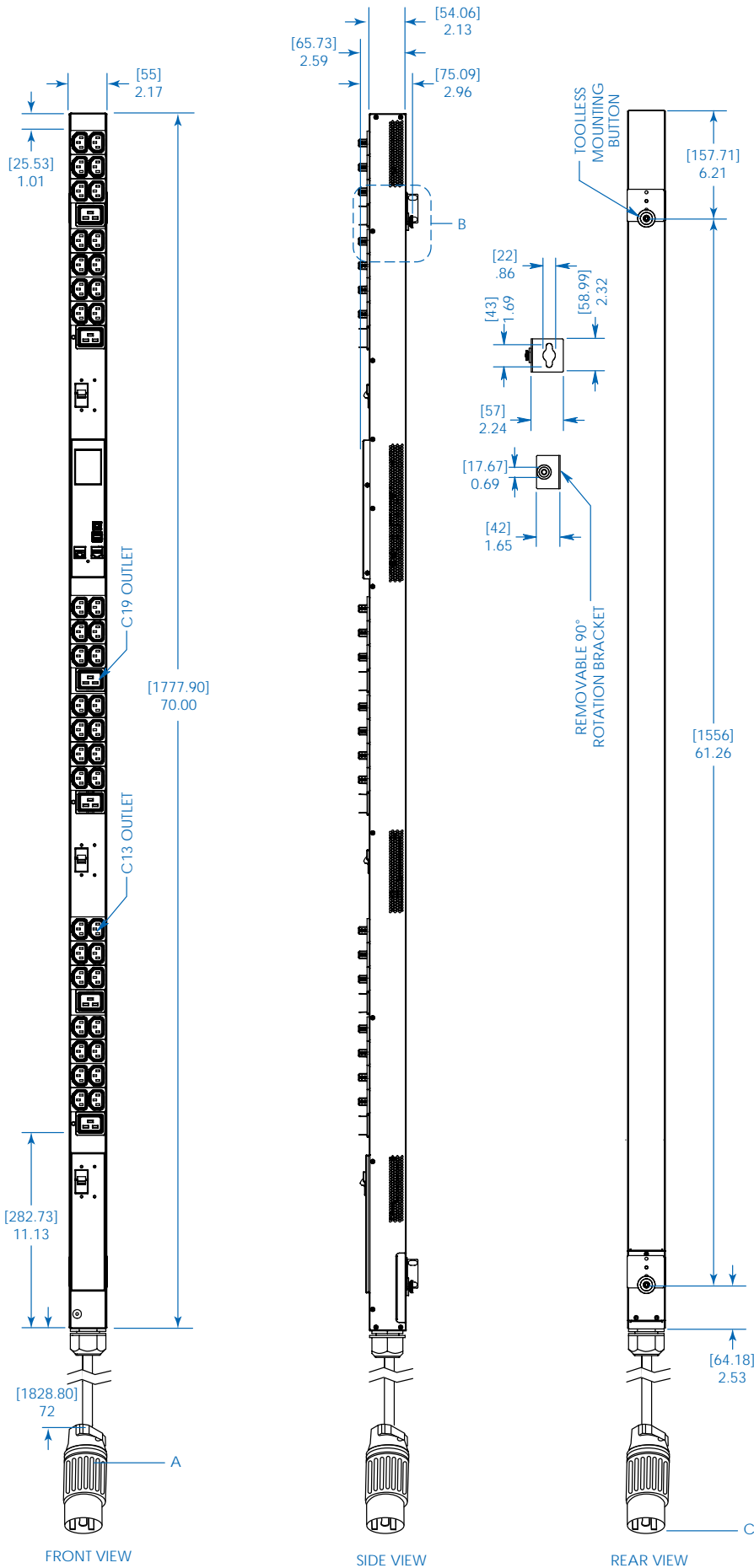

Dimensions: [mm] INCHES

Tripp Lite has a policy of continuous improvement. Specifications are subject to change without notice.

MODEL:
PDU3EVN6H50B

TRIPP-LITE

1111 W. 35th Street
Chicago, IL 60609 USA
773.869.1234

www.tripplite.com