

MODEL:

# PDU3EVN3L2130B

## 3-Phase Monitored Rack-Mount PDU



208/240V  
3-Phase Input



NEMA  
L21-30P Plug



208/240V  
Single-Phase  
Output



48 Outlets  
(C13 / C19)



10kW  
Load Capacity



Touchscreen  
LCD



HTML5  
Network  
Interface



0U  
Rack-Mount



Toolless  
Mounting  
Buttons



TAA  
Compliant

- A** Color Touchscreen LCD
- B** C13 and C19 Outlets with Multi-Function LEDs
- C** 20A 2-Pole Hydraulic Magnetic Circuit Breakers
- D** Plug-Lock Insert Sleeves
- E** Removable Mounting Brackets
- F** Toolless Mounting Buttons with Removable 90° Rotation Brackets
- G** 3 ft. Input Power Cord
- H** NEMA L21-30P Locking Input Plug
- I** Durable Metal Case
- J** LX Platform Interface
- K** USB-B Port
- L** USB-A Ports
- M** RJ45 Configuration Port
- N** RJ45 Ethernet Port
- O** SNMP Reset Button

Also Includes: Configuration Cable, Owner's Manual

Color Touchscreen LCD: Easily toggle between menus to monitor input current level per phase, output current per load bank, environmental sensor data and network information. It also generates a unique QR code to allow access to the monitored PDU through a mobile device.

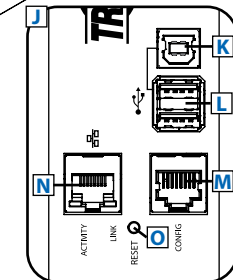
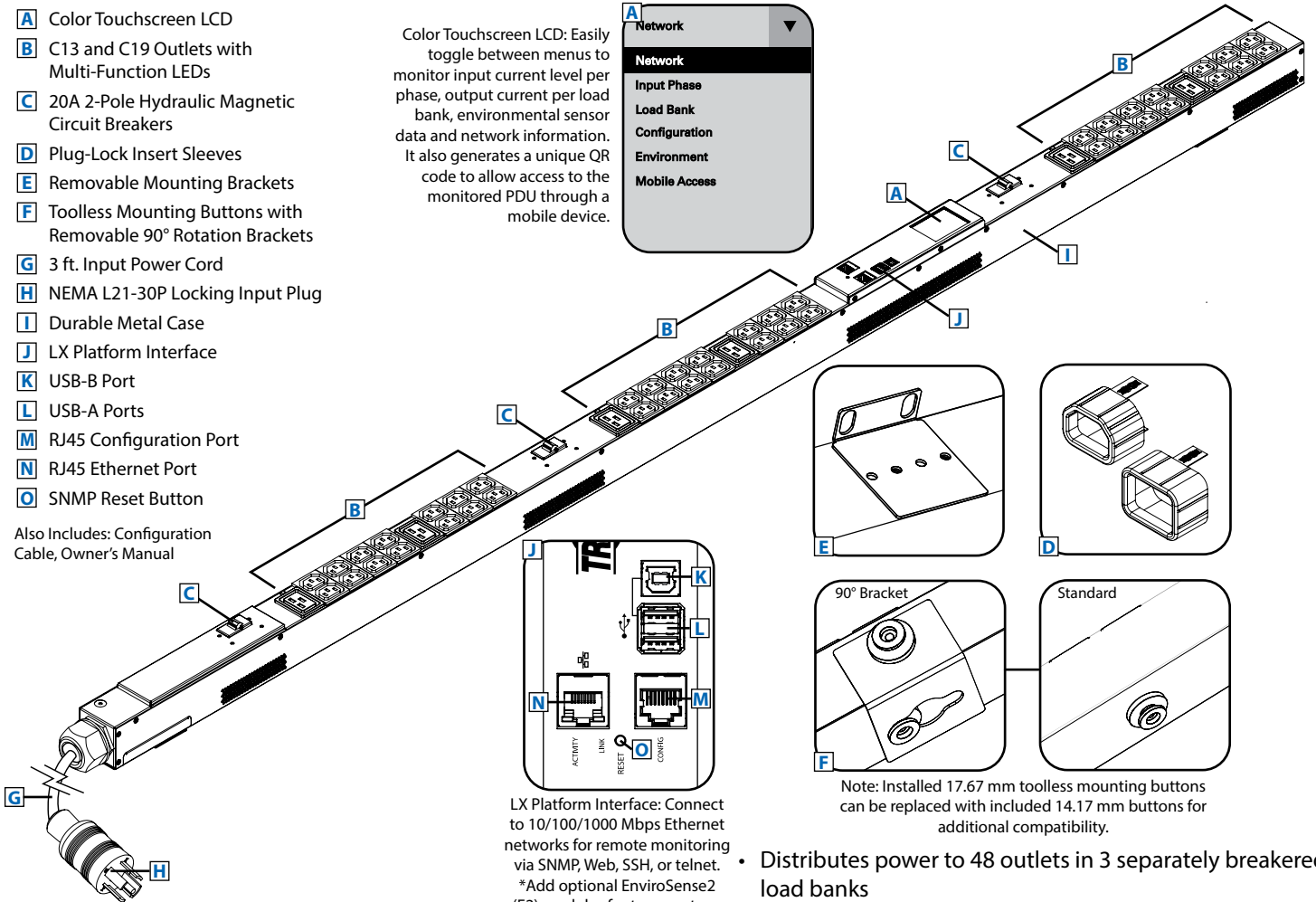
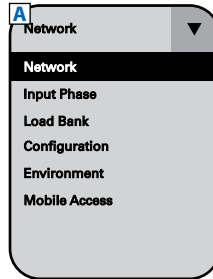

LX Platform Interface: Connect to 10/100/1000 Mbps Ethernet networks for remote monitoring via SNMP, Web, SSH, or telnet. \*Add optional EnviroSense2 (E2) modules for temperature, humidity, and dry contact signaling.

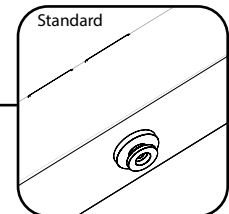
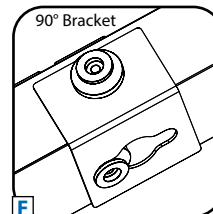
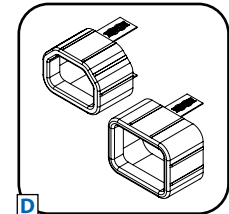
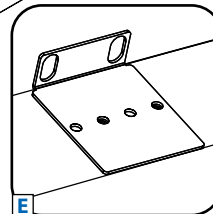

Note: Installed 17.67 mm toolless mounting buttons can be replaced with included 14.17 mm buttons for additional compatibility.

- Distributes power to 48 outlets in 3 separately breakered load banks
- Java-free HTML5-based network interface allows for remote monitoring via SNMP, Web, SSH or telnet
- Color touchscreen LCD displays input current per phase and output current per bank
- Recommended for rack-mount server, network and telecom applications

### Specifications

Model	PDU3EVN3L2130B
Voltage	208/240V (3-Phase Input, Single-Phase Output)
Frequency	50/60 Hz
Load Capacity	10kW (240V), 9.6kW (230V), 9.1kW (220V), 8.6kW (208V)
Input Connector	NEMA L21-30P
Cord Length	3 ft. / 0.9 m
Outlets	48 (42 C13 / 6 C19)
Primary Mounting Option	0U (Vertical) Rack-Mount
Unit Dimensions (H x W x D)	70 x 2.2 x 2.9 in. / 178 x 5.5 x 7.3 cm
Unit Weight	15.7 lb. / 7.1 kg
Standards	Tested to UL/CAN/CSA 60950-1 (U.S. & Canada), NOM (Mexico), FCC Class A Part 15, RoHS, TAA



SEE NEXT PAGE FOR DETAILED UNIT MEASUREMENTS



1111 W. 35th Street  
Chicago, IL 60609 USA  
773.869.1234  
www.tripplite.com

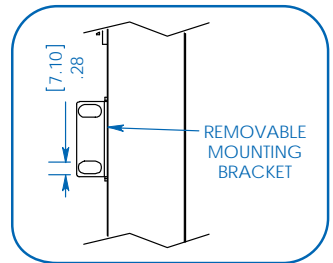
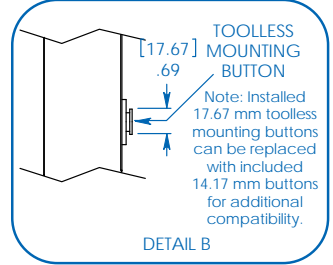
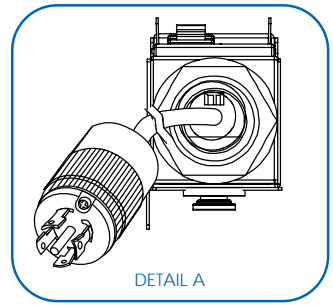
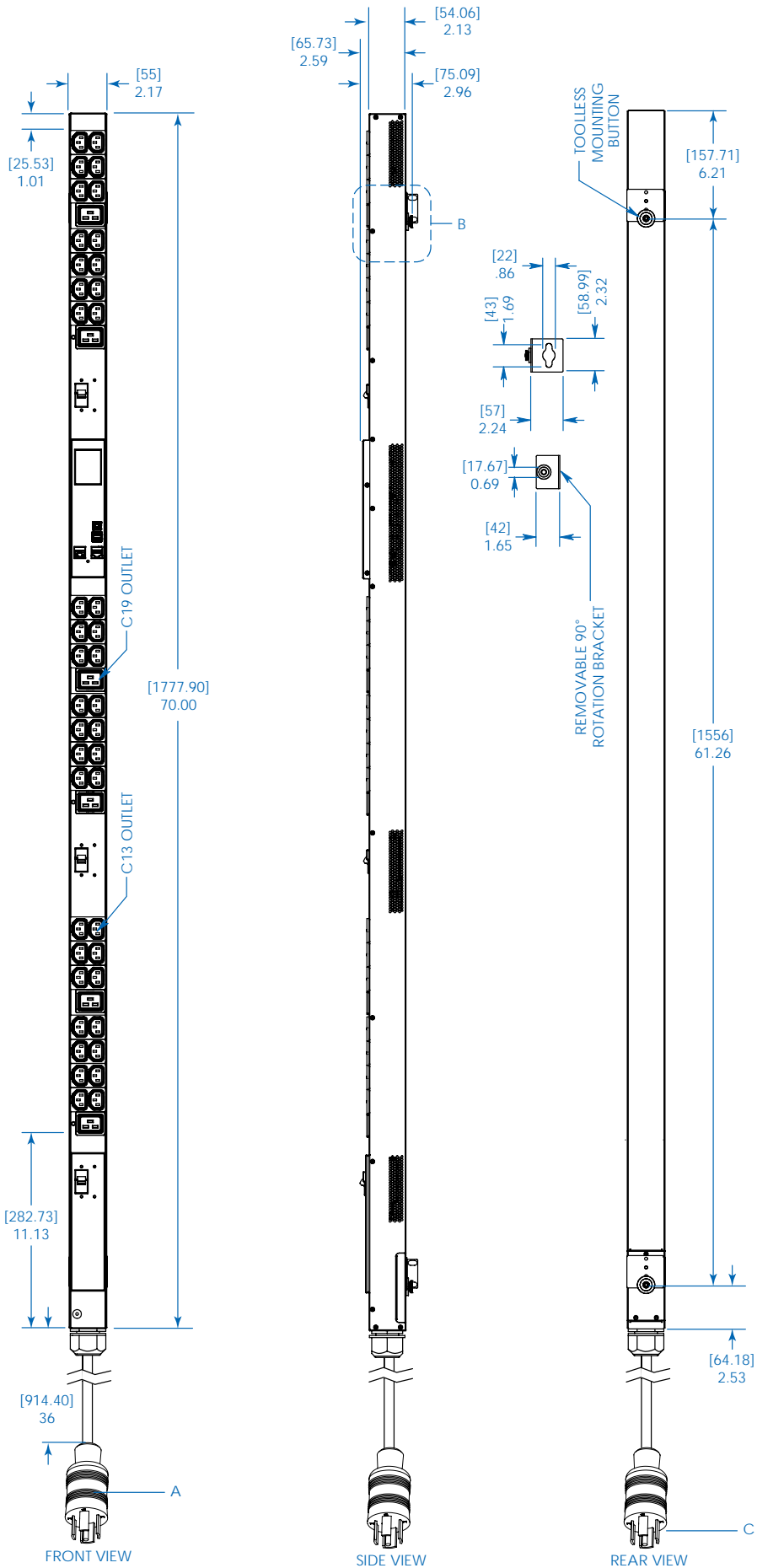

Dimensions: [mm] INCHES

Tripp Lite has a policy of continuous improvement. Specifications are subject to change without notice.

MODEL:  
**PDU3EVN3L2130B**



1111 W. 35th Street  
Chicago, IL 60609 USA  
773.869.1234

[www.tripplite.com](http://www.tripplite.com)