

Notes:
THIS DRAWING APPLIES SmartPro XL 2K LV 2U MODELS:

MGF ID	Catalog No	Short Description
9210-7138	SMART2200RM2UN	ripplite SmartPro 2200 2U w/NMC
9210-7139	SMART2200RM2U	ripplite SmartPro 2200 2U
9210-7140	SMART2200RMXLN	ripplite SmartPro XL 2200 2U w/NMC
9210-7141	SMART2200RMXL2U	ripplite SmartPro XL 2200 2U

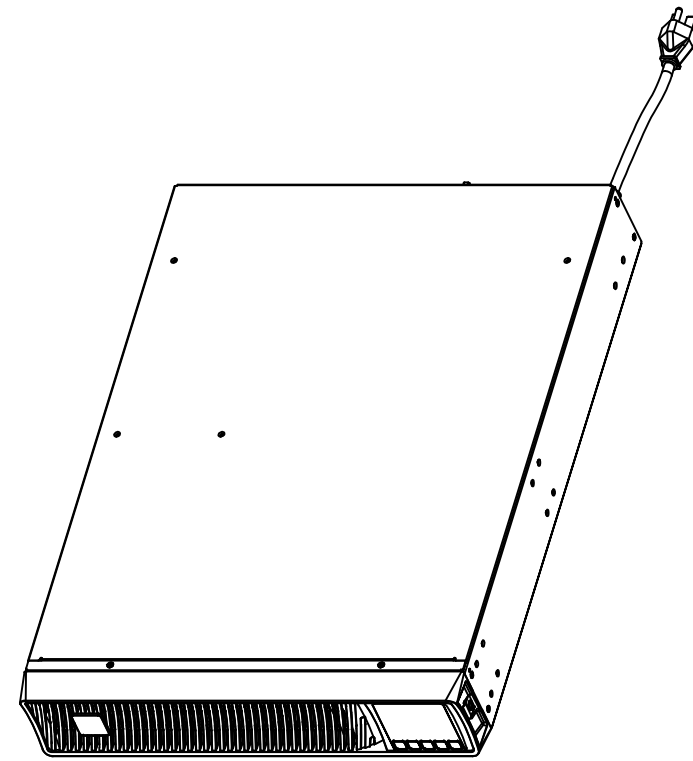

SCALE 0.150

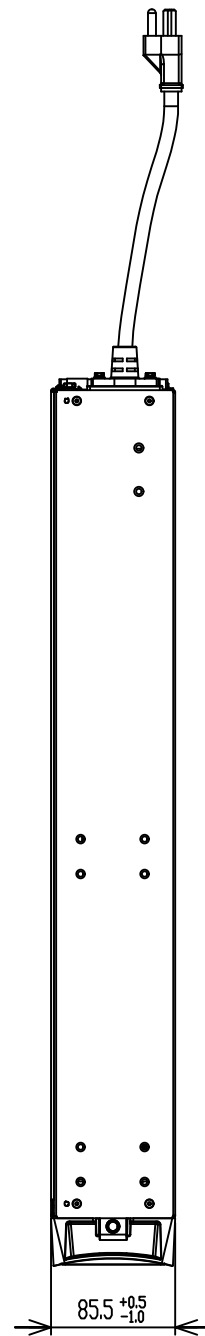
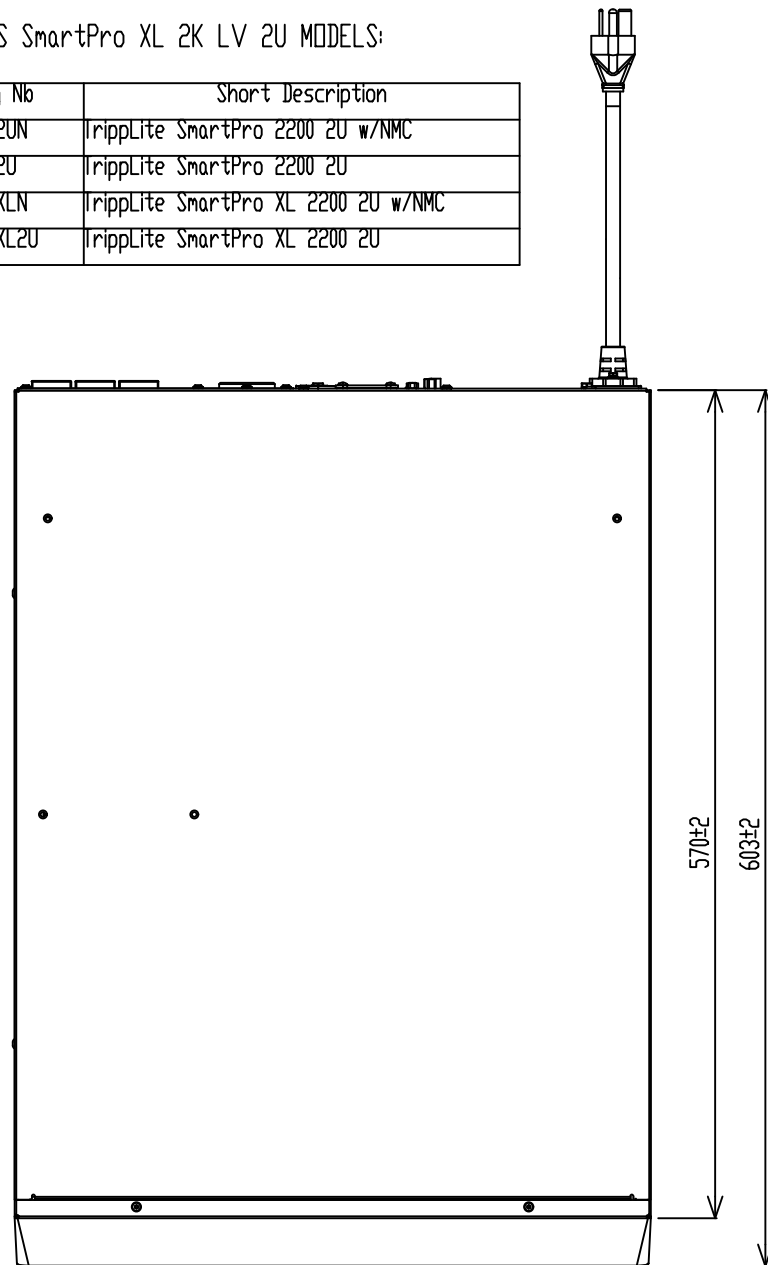
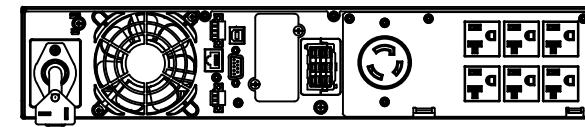

9210-7141-Rear Panel View

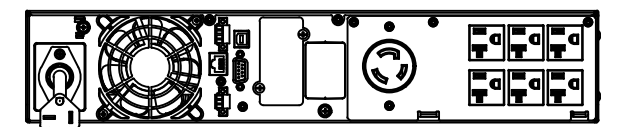

9210-7139-Rear Panel View(without battery connector)

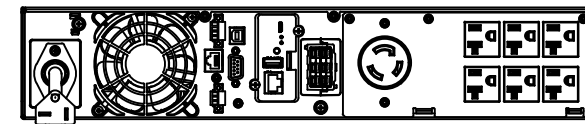

9210-7140-Netpack Model Rear Panel View

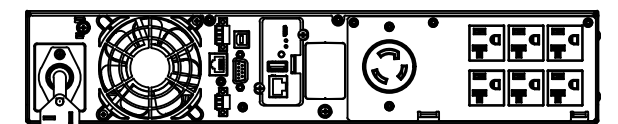

9210-7138-Netpack Model Rear Panel View(without battery connector)

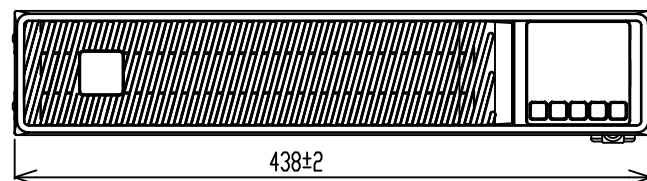

METRIC		 THIRD ANGLE PROJECTION		EATON	
DIMENSIONS ARE IN MILLIMETERS AFTER PLATING, DIMENSIONS AND TOLERANCES IN ACCORDANCE WITH ASME Y14.5M-1994. SEE NOTES FOR TOLERANCES.					
DESCRIPTION: SmartPro XL 2K LV 2U model					
ORIGINATED:	27-May-2022	ECD:	NAME:	REVISION:	SIZE: A3
MODIFIED:					SCALE: 0.200
CHECKED:		DOCUMENT TYPE:	SmartPro XL 2K LV	STATE:	SHEET: 1 OF 1
SAFETY:		PRO-E DRAWING			
APPROVED:					
©2024 Eaton. All rights reserved.					